

Data Sheet



Article number: 07112403001

Description: Universal joint single 0.112.403.001
S=310 X= Bore 45 H7 with keyway

Measures

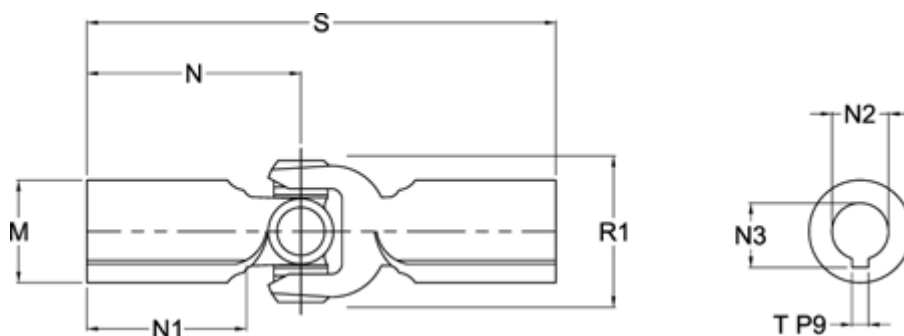

M	= 80	T = 14 P9
Max. Bending Angle degrees	= 35	
N	= 155	
N1	= 69	
N2	= 45 H7	
N3	= 48,8 +0,2	
R1	= 115	
S min	= 310	